

T018 4Pin

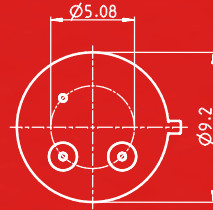

T039 3Pin

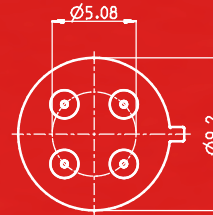

T039 4Pin

Package Outlines

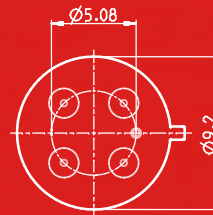

T039 5Pin

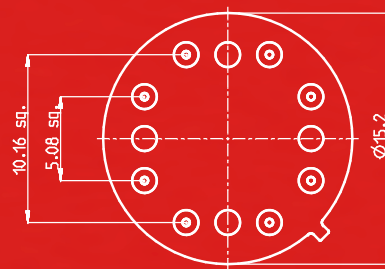

T08 8PIN

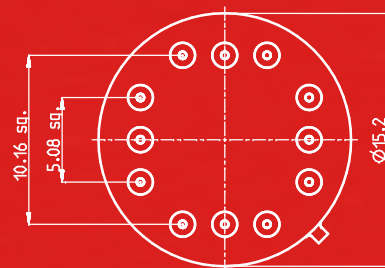

T08 12Pin

InfraTec pyroelectric detectors are distributed through a worldwide network to offer the best pre and post sales service for our customers. InfraTec operates direct branches in the UK and US. For the name and address of our subsidiary or distributor nearest you, please visit our website at www.InfraTec.de.



Quality made in Germany

InfraTec GmbH
Infrarotsensorik und Messtechnik
Gostritzer Straße 61-63
01217 Dresden/Germany
e-mail: sensor@InfraTec.de
www.InfraTec.de



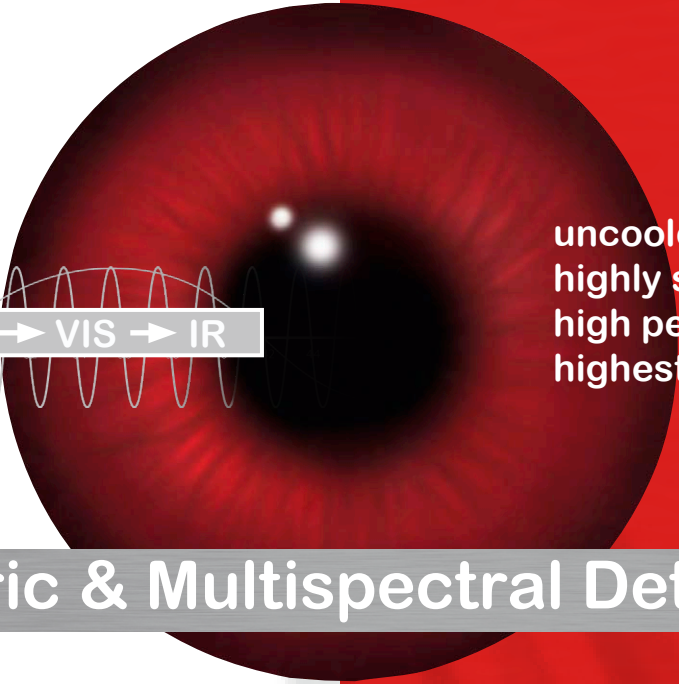
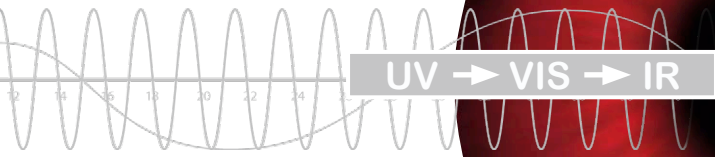

uncooled
highly stable
high performance
highest quality product

Pyroelectric & Multispectral Detectors

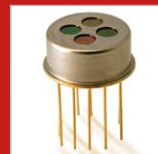
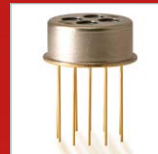

INFRATEC.

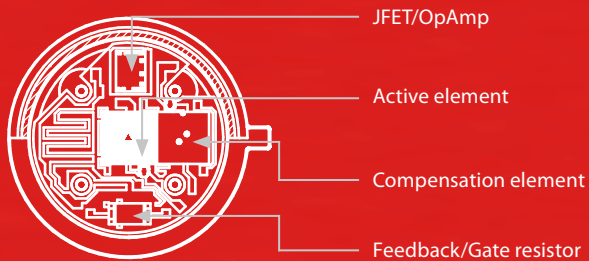
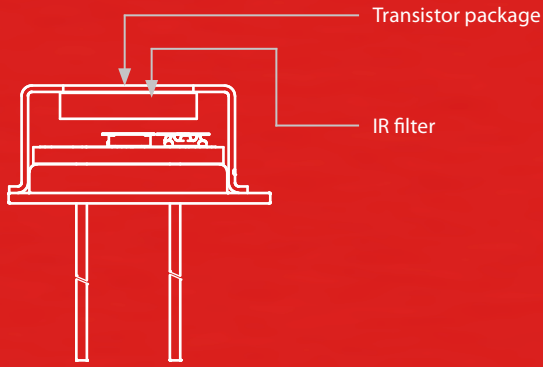

How does a detector work?

The key components of InfraTec's detectors are single crystalline lithium tantalate (LiTaO_3) elements formed like a very thin plate capacitor. Lithium tantalate is a pyroelectric crystal whose ends become oppositely charged when heated. The thin pyroelectric elements of InfraTec's detectors are coated with an appropriate 'black' absorbing layer to enhance the absorption of the incident infrared radiation in the wavelength range of interest, defined by an **IR filter**. The absorbed radiation energy changes the temperature of the thin **active element** thus charging the surface electrodes. Depending on the detector operating mode, the resulting current or voltage generated across the capacitance of the pyroelectric elements (typically 50 pF) is then converted into a useful signal. Even the low electrical charges generated by minimal increases in crystal temperature are protected reliably from external disturbances by a hermetically sealed **transistor package**. A low-leakage / low-noise preamplifier (**JFET or OpAmp**) and a **Feedback/Gate resistor** (typically 50G Ω) are included for current or voltage mode operation, usually in the **transistor package**.

It is important to note that an increase / decrease in detector package temperature (only in the temperature ramp!) can produce "false" signals. A **compensation element** shielded from the IR radiation and connected in an anti-parallel way suppresses this effect.

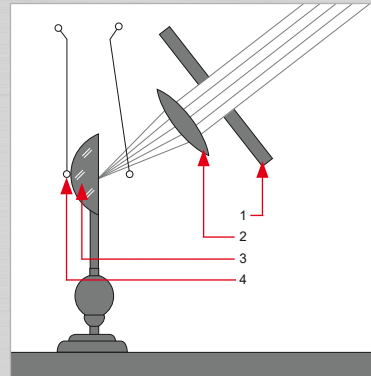

Experimental set-up of WILKE and AEPINUS dated 1762 containing components of a modern pyroelectric detector

1. Aperture
2. Lens
3. Tourmaline crystal
4. Electroscopes

Historical Background

Some important milestones in the evolution of infrared (IR) technology and InfraTec GmbH:

1800	Detection of infrared radiation in sunlight by HERSCHEL
1824	BREWSTER named the property of a tourmaline crystal that passes a current when heated as pyroelectric
1859	KIRCHHOFF introduced the term Black Body
1900	PLANCK formulated the Radiation Law
1940	KRS5 (a wide band IR window and lens material) is first manufactured by Carl Zeiss in Jena, Germany
1947	Invention of the transistor at the Bell Laboratories
1968	GLASS described the pyroelectric properties of lithium tantalate (LiTaO ₃) single crystals
1975	Formation of the Infrared Measurement Engineering Department at the Dresden University of Technology
1991	Foundation of InfraTec by graduate engineers from the "Dresden Infrared School"
2002	Production startup for the additional 5000 sqft clean room to support our constantly growing demand
2007	InfraTec's Sensor Division established the North American and the UK branch

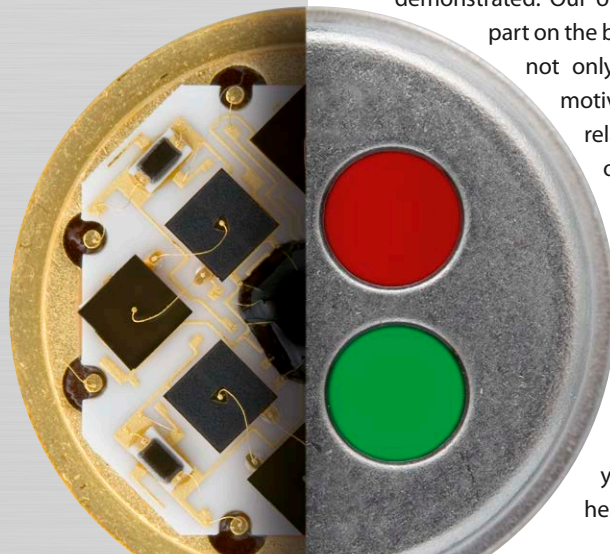

Our Corporate Philosophy

InfraTec is committed to become the most customer oriented infrared technology and pyroelectric detector manufacturer in the world. Throughout the 'development to production' cycle of our customers' projects or instruments, we take particular pride in the responsiveness all of our employees have demonstrated. Our operating philosophy is based in large part on the belief that our success can be attributed not only to our employees' high degree of motivation but also to the close working relationships we have established with our customers over the years. We have taken particular care in selecting our technical sales representatives worldwide to insure that they operate under the same philosophy. Together, we are eager to provide the application assistance and work closely with you to arrive at the optimum detector specifications for your requirement. We look forward to hearing from you.

The Company

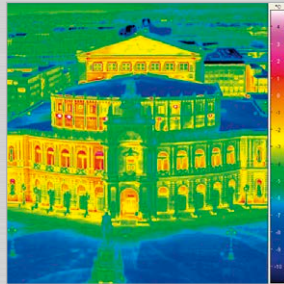
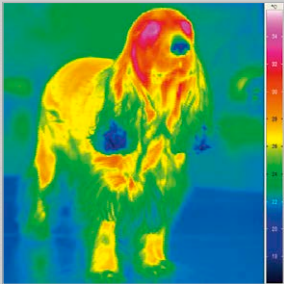

Infrared Measurement Division

InfraTec's Infrared Measurement Division offers turnkey system solutions to a wide range of thermographic and thermal imaging applications such as industrial security and quality assurance. Once a customer's requirements are defined, InfraTec specialists, with many years of infrared systems experience, work closely with customers, conduct application studies at the user site and verify results in our own laboratories. The result is an integrated system that includes both the operational hardware and software to insure successful deployment in the field. System hardware usually consists of appropriately specified, modern, high resolution, digital thermographic systems. IRBIS[®], developed by InfraTec engineers, is usually the software of choice that provides PC-supported data of both on-line and off-line image processing. Please contact our main office for additional and detailed information about the products and activities of this Division.



Sensor Division

The Sensor Division is staffed by technical personnel completely familiar with all facets of the design, manufacture, test and application of pyroelectric detectors. The division is fully equipped with an in-house capability for wafer processing, hybrid packaging, hermetic encapsulation and automated final testing. From prototypes to high volume production, we take pride in the unequalled quality and performance of our detectors and our demonstrated ability to respond to and support our customers' requirements in a timely and efficient manner. InfraTec's extensive standard pyroelectric detector list is constantly being expanded. It includes many innovative devices such as multi-color detectors with integrated beam-splitter and variable (tunable) color detectors (MOEMS based Fabry-Perot-Interferometer) each combined with CMOS-OpAmps as a state-of-the-art design for future advanced applications.

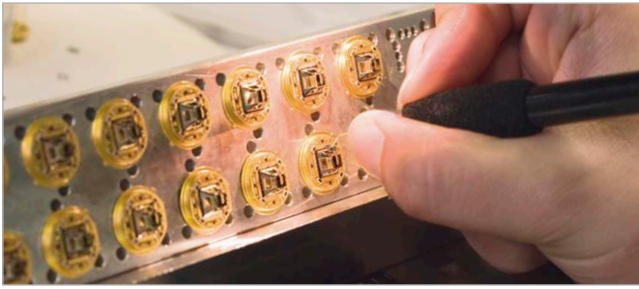

Research and Development

The Research and Development (R&D) Department of the Sensor Division is staffed by scientists with many years of experience in Micro-Optic-Electric-Mechanical-Systems (MOEMS) and other pertinent technologies. They are responsible for applying state-of-the-art designs and processes to these technologies for the improvement in cost and performance of InfraTec's family of detectors. InfraTec's ability to offer an innovative product line to meet the stringent customer requirements for pyroelectric detectors performance can be attributed to these efforts.

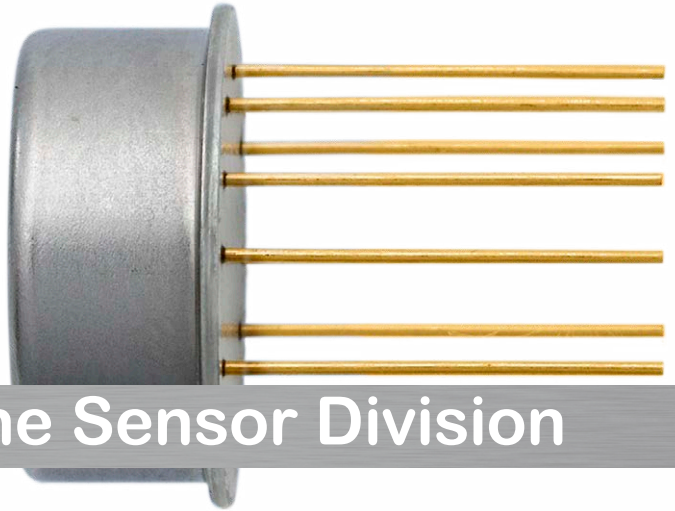

Product Range of the Sensor Division

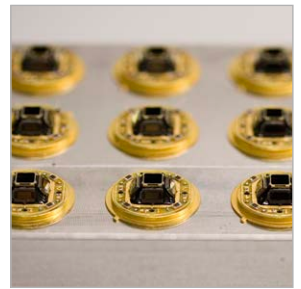
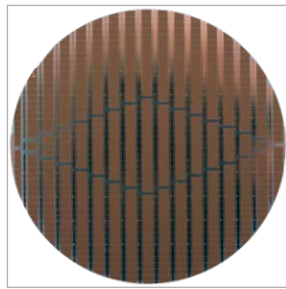
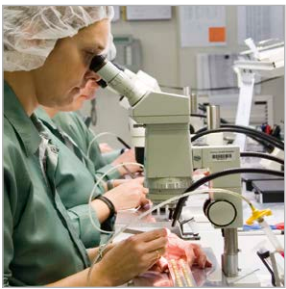

The Production

The production of pyroelectric infrared detectors in a complete in-house process demonstrates our fundamental approach. Without exception, only qualified and highly motivated skilled workers and engineers can guarantee long-term competence in the rapidly developing optical sensor engineering market. The production is divided into several work areas, which allow for flexible organization of the individual production processes. Key stages of production are:

Lithium tantalate wafer processing

- Thin film deposition of NiCr, Au
- Absorbing layers (polymer, metal black)

Hybrid packaging

- TO style transistor packages
- Low temperature gold wire bonding
- Hermetic encapsulation

IR window / filter assembly

- Epoxy sealing technologies for sensitive window materials

Test Capabilities

The main idea of the Quality Function Deployment determines the conceptual design, construction and distribution of our pyroelectric detectors, which perfectly match the customer requirements.

- Full simulation capability of standard and customized detector performance data and design
- Standardized kit for customized products
- Incoming Test, Lot Acceptance Test, In-Process Test, Screening
- Final Test / performance testing (100% burn-in test including leak test, 100% traceability by serial number for signal and noise testing)
- Test equipment coming up to the latest technologies, data processing and calibration standards
- A highly productive team of engineers is available to process customer inquiries regarding production and quality issues



Pyroelectric Detectors and their Applications

InfraTec detectors have blackened lithium tantalate elements. They distinguish themselves by a high response and signal-to-noise-ratio, a flat spectral response and highly stable operation over a wide range of temperatures. The majority of these detectors are internally compensated to reduce their response to thermal fluctuations of the environment.

Typical application fields are:



- NDIR gas analysis and IR flame detection
- Variety of analytical instruments for detection of radiation from deep UV to FIR (THz)
- Single and Multi-channel pyrometers

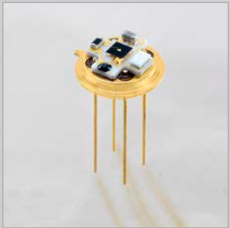

Standard Products

single-channel for gas analysis, flame detection and radiometry

- TO18 or TO39 housing
- Thermal compensation
- JFET or CMOS amplifier

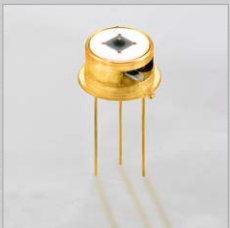

Extended Products

single-channel for analytical instruments and spectroscopy

- High performance
- Fast response
- Metal black coating

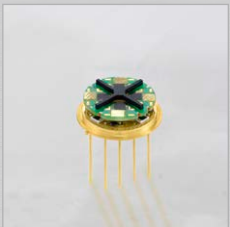

Multi-color Products (Pyromid®)

dual or quad channel for gas analysis and flame detection

- Cross talk <0.1%
- JFET or CMOS amplifier
- Optionally with beamsplitter

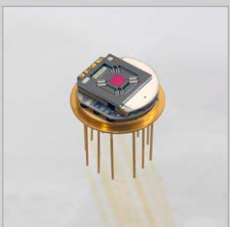

Variable color Products (FPI)

spectrometer device for analytical and gas sensing instruments

- Electrostatic drive
- > 1 μ m tuning range
- Resolving power $\lambda/\Delta\lambda$ up to 60